

ICS5400 Series Rack-mounted Layer 3 Industrial Ethernet Switch Quick Installation Guide

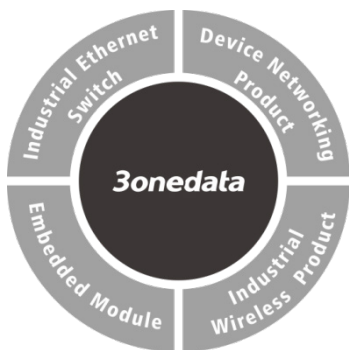

3onedata Co., Ltd.

Address: 3/B, Zone 1, Baiwangxin High Technology Industrial Park, Xili, Nanshan District, Shenzhen

Website: www.3onedata.com

Tel: +86 0755-26702688

Fax: +86 0755-26703485

【Package Checklist】

Please check the integrity of package and accessories while first using the switch.

1. Switch ×1
2. Mounting lug x2
3. AC power line x2 (AC product only)
4. Warranty card
5. Certificate

If any of these items are damaged or lost, please contact our company or dealers, we will solve it ASAP.

【Product Overview】

This series are rack-mounted layer 3 industrial Ethernet switches. For convenience, the products of this series adopt the following number on the left in this guide, please confirm the number of your product:

Model I. ICS5400-24GT4XS-2LV (24 Gigabit copper ports + 4 10G SFP+ slots, 12~55VDC redundant power supply).

Model II. ICS5400-12GT16GS4XS-2LV (12 Gigabit copper ports + 16 Gigabit SFP slots + 4 10G SFP+ slots, 12~55VDC redundant power supply)

Model III. ICS5400-24GT8GS4XS-2LV (24 Gigabit copper ports + 8 Gigabit SFP slots + 4 10G SFP+ slots, 12~55VDC redundant power supply)

Model IV. ICS5400-24GT16GS4XS-2LV (24 Gigabit copper ports + 16 Gigabit SFP slots + 4 10G SFP+ slots, 12~55VDC redundant power supply)

Model V. ICS5400-24GT4XS-2HV (24 Gigabit copper ports + 4 10G SFP+ slots, 85~264VAC redundant power supply).

Model VI. ICS5400-12GT16GS4XS-2HV (12 Gigabit copper ports + 16 Gigabit SFP slots + 4 10G SFP+ slots, 85~264VAC redundant power supply)

Model VII. ICS5400-24GT8GS4XS-2HV (24 Gigabit copper ports + 8 Gigabit SFP slots + 4 10G SFP+ slots, 85~264VAC redundant power supply)

Model VIII. ICS5400-24GT16GS4XS-2HV (24 Gigabit copper ports + 16 Gigabit SFP slots + 4 10G SFP+ slots, 85~264VAC redundant power supply)

【Panel Design】

➤ DC device: front view

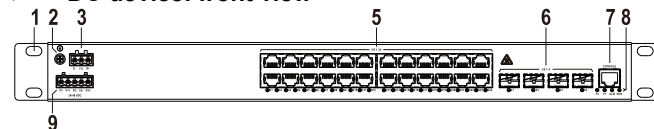

Model I

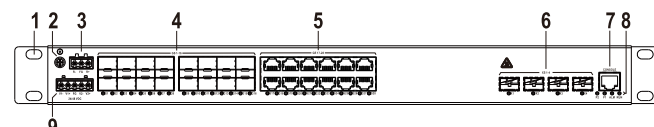

Model II

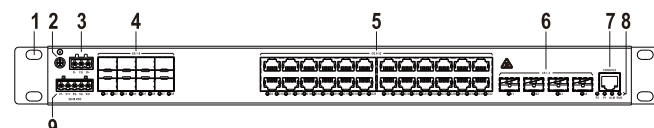

Model III

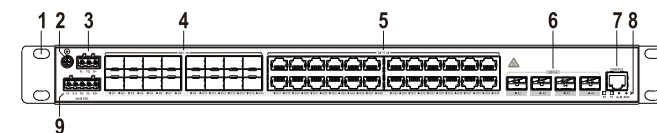

Model IV

➤ DC device: rear view



➤ AC device: front view

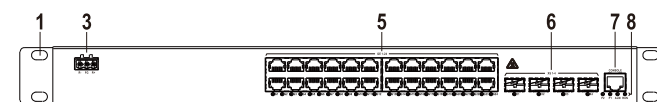

Model V

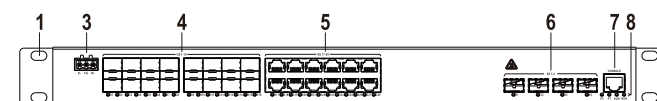

Model VI

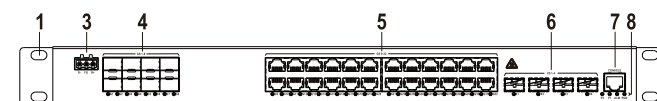

Model VII

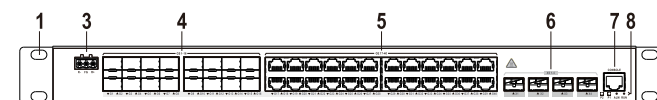

Model VIII

➤ AC device: rear view



1. Lugs
2. Grounding screw (M4)
3. Relay alarm output interface
4. 100/1000Base-X Gigabit SFP slot (GS 1-16/1-8)
5. 10/100/1000Base-T(X) Gigabit copper port (GE 1-24 / 17-28 / 17-32 / 9-32 / 17-40)
6. 1G/2.5G/10GBase-X 10Gigabit SFP+ slot (XS 1-4)
7. CONSOLE port

8. Device indicators, from left to right in turn they are:
 - Ethernet port indicator (G1-G24/28/32/40, X1-X4)
 - Power indicator (P2-P1)
 - Alarm indicator (ALM)
 - Running indicator (RUN)
9. DC power supply input terminal blocks
10. AC power 2 supply input socket (PWR2)
11. AC power 1 input socket (PWR1)

【Mounting Dimension】

The external dimensions of this series of products are the same, unit: mm.

➤ DC device

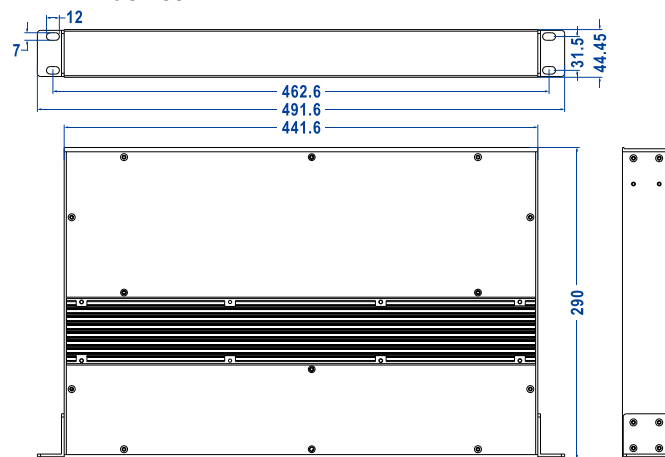

➤ AC device

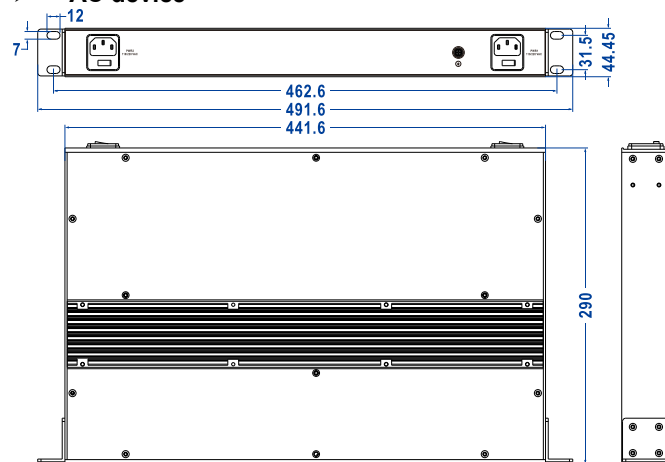

Notice Before Mounting:

- Don't place or install the device in area near water or moist, keep the relative humidity of the device surrounding between 5%~95% without condensation.
- Before power on, first confirm the supported power supply specification to avoid over-voltage damaging the device.
- The device surface temperature is high after running; please don't directly contact to avoid scalding.

【Rack-mounted】

This product adopts 1U rack-mounting, mounting steps as below:

- Step 1 Select the device mounting location to ensure enough size.
- Step 2 Adopt 4 bolts to install the mounting lugs in the device position as figure below.

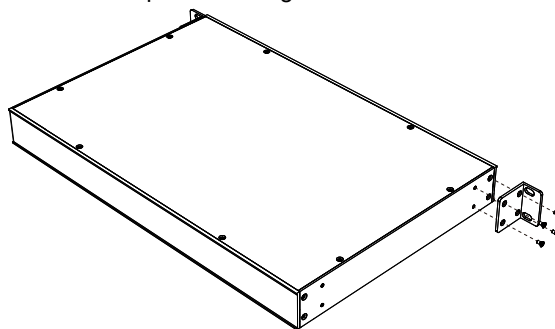

- Step 3 Place the device in the rack; adopt 4 bolts to fix two sides mounting lugs in the rack.

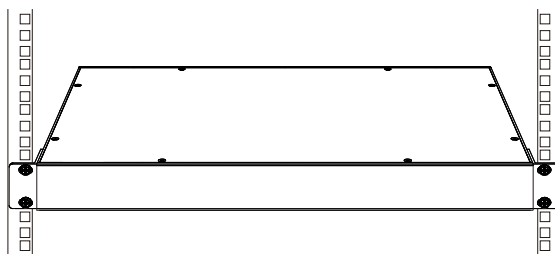

- Step 4 Check and confirm the product is mounted firmly on

the rack, mounting ends.

【Disassembling Device】

- Step 1 Power off the device.
- Step 2 Adopt screw driver to loosen the 4 bolts fixed on the mounting lugs in the rack.
- Step 3 Shift out the device from rack, disassembling ends.



Notice before power on:

- Power ON operation: First insert the power supply terminal block into the device power supply interface, then plug the power supply plug contact and power on.
- Power switch “—” means power ON, “O” means power OFF.
- Power OFF operation: First, put the powers switch to the "O" side and then disconnect the power supply. Finally disconnect the connector between the device and the power cord. Please notice the operation order above.
- Please be aware of the power input range supported by the device before powering on. Use the recommended voltage of the device to avoid device damage.

【Power Supply Connection】

➤ DC device power supply

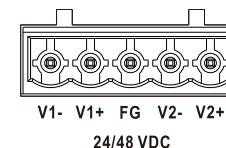

Model I- Model IV provide 5-pin 5.08mm pitch terminal blocks and the built-in dual power supply redundancy supports DC power input. The power input supports 1 single power supply

input or 2 power supply inputs at the same time; When two power supply input at the same time, it supports redundant backup of power supply. If one power supply fails, the device can still work normally without interruption. Power supply supports anti-reverse connection, which cannot power the device but won't damage it when it's reversely connected. The definitions of power pin are shown in the left figure, and the power input range is 24VDC/48VDC (12~55VDC).

➤ AC device power supply

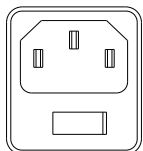

PWR1
110/220 VAC

Model V-Model VIII provides 2 AC power sockets with switch, PWR1 and PWR2, and supports AC power supply input. The power input supports 1 single power supply input or 2 power supply inputs at the same time; When two power supply input at the same time, it supports redundant backup of power supply. If one power supply fails, the device can still work normally without interruption. Power supply input range: 110VAC/220VAC (85~264VAC).

【Relay Connection】

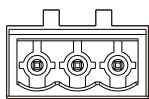

R- FG R+

Provide 3-pin 5.08mm pitch terminal block, support 1 relay alarm output. In power off situation, R- and R+ are a group of normally closed contacts. After powered on, the relay is open circuit in normal non-alarm state by default, closed when any alarm information occurs. The relay supports power supply alarm or network abnormality alarm. It can be connected to alarm light or alarm buzzer or other switching value collecting devices, which can timely inform operators when the alarm occurs.

【Console Port Connection】

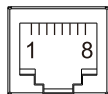

Provide 1 program debugging port based on RS-232 serial port which can conduct device CLI command management after connecting to PC. The interface adopts RJ45 port, the RJ45 pin definitions are as follows:

Pin No.	2	3	5
Definition	TXD	RXD	GND

【Checking LED Indicator】

Provide LED indicators to monitor its operating status, which has simplified the overall troubleshooting process. The function of each LED is described in the table below:

LED	Indicate	Description
P1/P2	ON	Power P1/2 is running normally
	OFF	Power P1/2 is disconnected or running abnormally

LED	Indicate	Description
ALM	ON	Power supply or port link has alarm
	OFF	Power supply, port link without alarm
RUN	ON	The device is running abnormally
	Blinking	Blinking 1 time per second, system is running normally
	OFF	The device is powered off or the device is abnormal.
LINK (G1-24/28/32/40, X1-X4)	ON	Ethernet port has established a valid network connection
	Blinking	Ethernet port is in an active network status
	OFF	Ethernet port has not established valid network connection

【Logging in to WEB Interface】

Support WEB management and configuration. Computer can access the device via Ethernet interface. The way of logging in to device's configuration interface via browser is shown as below:

- Step 1 Configure the IP addresses of computer and the device to the same network segment, and the network between them can be mutually accessed.
- Step 2 Enter device's IP address in the address bar of the computer browser.

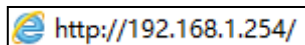

- Step 3 Enter device's username in the login window as shown below.

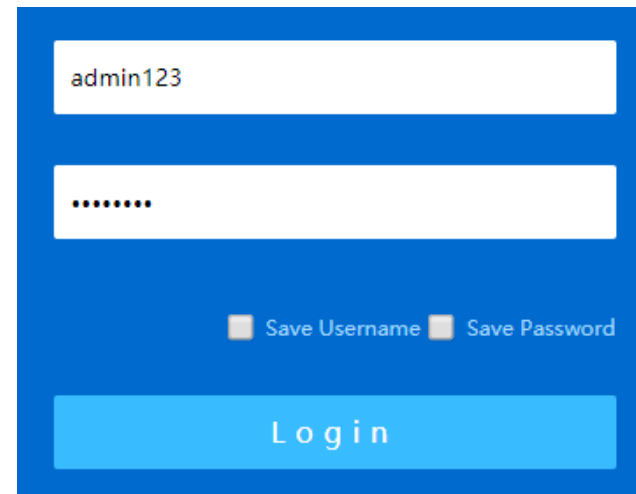

- Step 4 Click "Login" button to login to the WEB interface of the device.



Note:

- The default IP address of the device is "192.168.1.254".
- The default username and password of the device are "admin123".
- If the username or password is lost, user can restore it to factory settings via management software; all modified configurations will be cleared after restoring to factory settings, so please backup configuration file in advance.
- Please refer to user manual for specific configuration method of logging in to WEB interface and other configurations about network management function.

【Specification】

Panel	
Gigabit copper port	10/100/1000Base-T(X) self-adaption or forced mode, RJ45, Automatic Flow Control, Full/Half Duplex Mode, MDI/MDI-X Autotunning
Gigabit SFP	100/1000Base-X self-adaption or forced mode, SFP slot

10Gigabit SFP+	1G/2.5G//10GBase-X self-adaption or forced mode, SFP+ slot
Relay	1 relay alarm information output, using 3-pin 5.08mm pitch terminal blocks, and the current load capacity is 1A@30VDC or 0.3A@125VAC
CONSOLE port	CLI command line management port (RS-232), RJ45
Indicator	Power indicator, alarm indicator, running indicator, interface indicator
Switch Property	
Backplane bandwidth	160G
Packet buffer size	32Mbit
MAC Address Table	32K
Power Supply	
Model I-Model IV	24VDC/48VDC (12~55VDC), dual power supply redundancy, using 5-pin 5.08mm pitch terminal blocks, support anti-reverse connection
Model V-Model VI	110VAC/220VAC (85~264VAC), dual power supply redundancy, using AC socket with switch
Power Consumption	
Full-load	<47.3W
Working Environment	
Working temperature	-40~75°C

Storage temperature	-40~85°C
Working humidity	5%~95% (no condensation)
Protection grade	IP40 (metal shell)

【Disposal of Waste Electrical and Electronic Equipment (WEEE 2012/19/EU)】

(Applicable in the EU-member states)

The crossed-out wheeled bin symbol on the equipment or its packaging indicates that the product, at the end of its service life, shall not be mixed with unsorted municipal waste but should be collected separately, in accordance with local laws and regulations.

A proper separate collection of end-of-life equipment for the subsequent recycling, treatment and environmentally compatible disposal, will help prevent potential damage to the environment and human health, facilitating the reuse, recycling and/or recovery of its component materials.

Private users should contact their vendor or municipal waste management service and ask for disposal information.

Professional users should contact their suppliers and check the terms of their selling agreement.

This product must not be disposed of with other commercial waste.

Users' cooperation in the correct disposal of this product will contribute to saving valuable resources and protecting the environment.

