

# FR-2024iT

## Analog Output Module

250 kS/s, 12-bit, 4 Channel Isolated

### User Manual

Version 1.0.4/October 2017



## **Warranty**

---

All products manufactured by ICP DAS are under warranty regarding defective materials for a period of one year, beginning from the date of delivery to the original purchaser.

## **Warning**

---

ICP DAS assumes no liability for any damage resulting from the use of this product. ICP DAS reserves the right to change this manual at any time without notice. The information furnished by ICP DAS is believed to be accurate and reliable. However, no responsibility is assumed by ICP DAS for its use, not for any infringements of patents or other rights of third parties resulting from its use.

## **Copyright**

---

Copyright © 2017 by ICP DAS Co., Ltd. All rights are reserved.

## **Trademark**

---

The names used for identification only may be registered trademarks of their respective companies.

## **Contact us**

If you have any problem, please feel free to contact us.  
You can count on us for quick response.

Email: [service@icpdas.com](mailto:service@icpdas.com)

# Table of Contents

<b>Table of Contents .....</b>	<b>3</b>
<b>1. Introduction.....</b>	<b>5</b>
1.1. Features.....	6
1.2. Specification.....	7
1.3. Overview.....	9
1.4. Pin Assignments and Wire Connections .....	12
<b>2. Getting Started.....</b>	<b>13</b>
2.1. Hardware Installation .....	13
2.2. Software Installation.....	15
2.3. Configuration.....	16
2.3.1. Getting help – FR-2024 Configuration.....	19
2.3.2. Limiting the Output .....	20
2.3.3. Configuring the Operation Settings .....	21
<b>3. FRnet Application.....</b>	<b>23</b>
3.1. PAC-Based System .....	27
3.1.1. i8172_WriteAOHex.....	28
3.1.2. i8172_WriteAOFloat.....	30
3.1.3. i8172_AOHexToFloat.....	32
3.1.4. i8172_AOFloatToHex.....	33
3.2. PC-Based System.....	34
3.2.1. FRnet_WriteAOHex.....	35

3.2.2.	FRnet_WriteAOFloat.....	36
3.2.3.	Modbus and DCON Commands.....	38
3.3.	uPAC-Based System .....	44
<b>4.</b>	<b>Error Codes.....</b>	<b>45</b>

# 1. Introduction

The FR-2024 is a 12-bit, 4-ch analog outputs FRnet module that provides programmable output range (0 ~ + 10 VDC, -10 VDC ~ +10 VDC, 0 ~ +5 VDC, -5 VDC ~ +5 VDC, 0 ~ +20mA, +4mA ~ +20mA). There are options for power on value and Safe Value for your consideration. It also has 240Vrms high over voltage protection for all analog outputs.



## What is FRnet?

FRnet is a two-wire serial communication bus, wired in a similar manner to an RS-485. FRnet device connection is achieved using a multi-drop method. Unlike most communication methods based on RS-485, this new method does not use the traditional question/answer approach. Instead, it uses a fixed scan time to actively transmit data. Since there is no need for a CPU to process a communication protocol, FRnet can achieve high-speed data transmission in an isochronous manner. When FRnet is adopted as the I/O interface in an embedded controller, control of I/O data can be easily achieved by reading/writing to the memory (memory-mapped I/O), making the development of application programs very simple, which not only saves a great deal of time in communication protocol processing, but also guarantees the isochronous properties. Therefore, FRnet is highly suitable for applications that require remotely controlled, high-speed data transmission, and allows for major savings when wiring.

# 1.1. Features

## Features

- Built-in wire-saving FRnet control
- High-speed transmission reliability
- Simple synchronization mechanism
- No software overhead on protocol processing
- Supporting broadcasting (1:n data transmission)
- Duplicating output easily
- Fixed I/O scan-time and I/O synchronization
- DIN-Rail mountable

## Application

- Automatic equipment and related systems
- Airport landing lamp control systems
- Automatic warehouse control systems
- Disaster warning and security systems
- Parking lot management systems
- Fruit classification and packing systems
- Remote control
- Post Office letter classification machine systems
- Communication between PLCs
- New LED control technology
- Light control
- 4D theaters
- Monitoring of debris flow and landslides
- Building Automation
- Elevator control
- Air-conditioning systems
- Power monitoring

## 1.2. Specification

<b>Analog Output</b>	
Output Channels	4
Output Type	0 ~ 20 mA, 4 ~ 20 mA, 0 ~ 5 V, +/- 5 V, 0 ~ 10 V, +/- 10 V
Resolution	12-bit
Accuracy	+/- 0.1 % for FSR
Zero Drift	Voltage: +/- 30 $\mu\text{V}/^\circ\text{C}$ , Current: +/- 0.2 $\mu\text{A}/^\circ\text{C}$
Span Drift	+/- 20 ppm/ $^\circ\text{C}$
DA Output Response Time	10 ms per channel
Programmable Output Slope	0.125 to 2048 mA/second, 0.0625 to 1024 V/second
Voltage Output Capability	10V @ 20 mA
Current Load Resistance	External + 24 V: 1050 Ohms
Power-Up and Safe Value	Yes
<b>Interface</b>	
Isolation Voltage	2500 V <sub>DC</sub>
2-Wire Cabling	Belden 8941 (2P twisted-pair cable), when different cables are used, the transmission distance may be changed
Transfer Distance	Max. 400 m for speed 250 K Max. 100 m for speed 1 M (Default)
LED Indicators	Power, Communication Run, Communication Error, Terminal Resistor
Transfer Speed	250 KB or 1 MB (Default), DIP switch selectable
Cyclic Scan Time	2.88 ms for speed 250 K, 0.72 ms for speed 1 M (Default)
<b>Power</b>	
Input Voltage Range	+10 ~ +30 V <sub>DC</sub> (non-isolation)
Power Consumption	2.88 W Max.
Connector	5-Pin removable terminal block

<b>EMS Protection</b>	
ESD (IEC 61000-4-2)	4 kV contact for power line, communication line and each channel, 8 kV air for random point
EFT (IEC 61000-4-4)	4 kV for power liner
Surge (IEC 61000-4-5)	3 kV for power liner
<b>Case</b>	
Mechanical	Plastic
Flammability	UL 94V-0 Materials
Dimensions (W x H x D)	32.5 x 110 x 102 mm
Installation	DIN-Rail
<b>Environment</b>	
Operating temperature	-25 ~ +75 °C
Storage temperature	-30 ~ +85 °C
Humidity	10 ~ 90 % RH, non-condensing



## 1.3. Overview

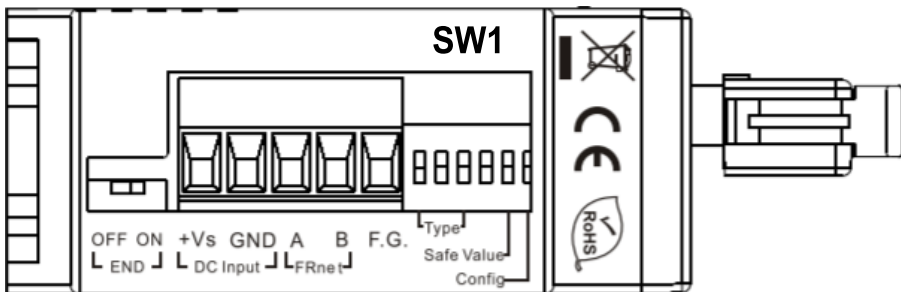

**OFF (END):** 120 R terminating resistor Disable

**ON (END):** 120 R terminating resistor Enable

In addition to these connectors, there is also one switch on the side of the module which can decide to use the internal terminal resistor on the network or not. If you switch it on, it means that the module will provide the terminal resistor on the network. Note that each network needs two modules to be on, which are usually the first and last module on the network.

**+Vs (DC Input):** Power input (+10 to +30 V) and should be connected to the power supply (+)

**GND (DC Input):** Ground and should be connected to the power supply (-)

**A (FR-net):** Communication line “A (Data+)”

**B (FR-net):** Communication line “B (Data-)”

**F.G.:** F.G. stands for Frame Ground (protective ground). It is optional. If you use this pin, it can reduce EMI radiation; improve EMI performance and ESD protection.

**SW1:** The SW1 switch can be used to configure the output type of the analog output, the safe value of analog output when FRnet communication failed and Software configuration/DIP Switch configuration.

The table below shows the function list of SW1 DIP switch.

DIP Switch	Function
1 <sup>st</sup> ~ 3 <sup>rd</sup>	The 1 <sup>st</sup> ~ 3 <sup>rd</sup> DIP switch allows users to configure the output range: Please see the next table.
4 <sup>th</sup>	Reserved
5 <sup>th</sup>	Safe Value: ON: Output safe values when FRnet communication failed OFF: Output not changed when FRnet communication failed
6 <sup>th</sup>	Software Configuration: ON: Software configuration OFF: DIP Switch configuration

The Maximum and Minimum mapping table of analog output.

Output Type	SW1			Minx	Max.
	1	2	3		
0 ~ 20 mA	ON	ON	ON	000 (0 mA)	FFF (20 mA)
4 ~ 20 mA	OFF	ON	ON	000 (4 mA)	FFF (20 mA)
0 V ~ +5 V	ON	ON	OFF	000 (0 V)	FFF (+5 V)
-10 V ~ +10 V	OFF	ON	OFF	800 (-5 V)	7FF (+5 V)
0 V ~ +10 V	ON	OFF	ON	000 (0 V)	FFF (+10 V)
-10 V ~ +10 V	OFF	OFF	ON	800 (-10 V)	7FF (+10 V)

There are several LED indicators located on the top side of the module. They are Power LED, Communication Run LED, Communication error LED, I/O LED and termination resistor LED. Users can understand the meaning directly from the label on the LED indicator. Note that the Communication Run LED and the Communication error LED illustrate whether the quality of communication is OK or not.

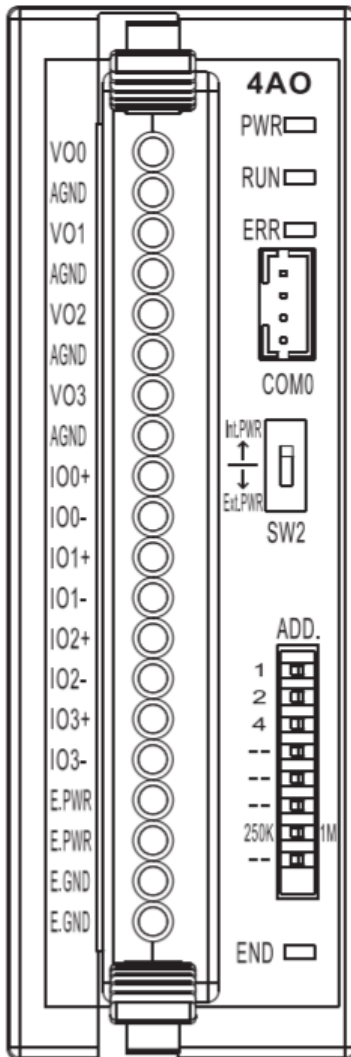

LED Indicator		
PWR	Yellow	Power LED
RUN	Green	Communication run LED
ERR	Red	Communication error LED
END	Yellow	Terminal resistor On

DIP Switch	
1 <sup>st</sup>	Module Address:0~7
2 <sup>nd</sup>	
3 <sup>rd</sup>	
4 <sup>th</sup>	Reserved
5 <sup>th</sup>	Reserved
6 <sup>th</sup>	Reserved
7 <sup>th</sup>	Speed: ON → 250k bps OFF → 1M bps
8 <sup>th</sup>	Reserved

COM0
Each analog channel is allowed to configure an individual range by CA-0904 cable.

# 1.4. Pin Assignments and Wire Connections

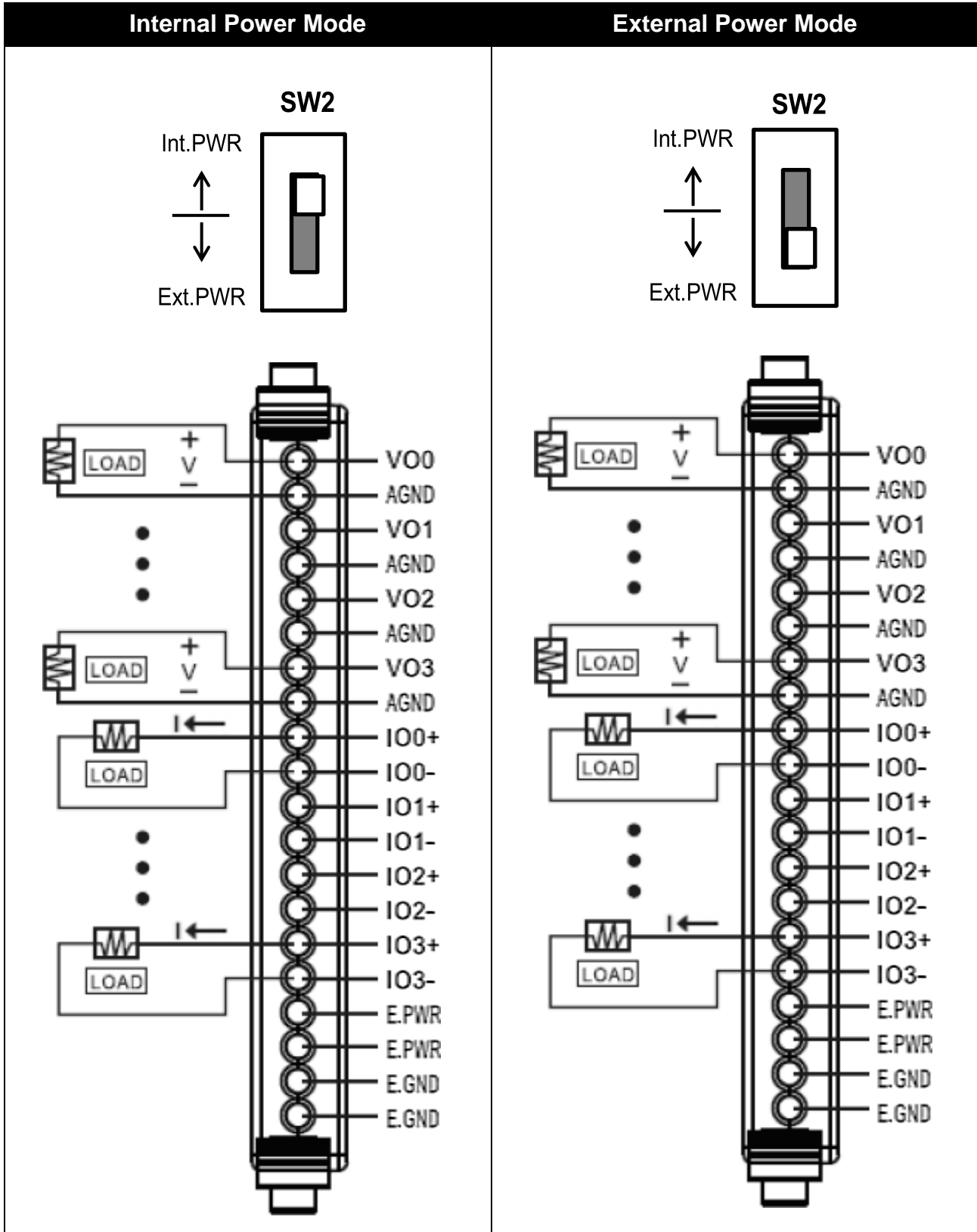

## 2. Getting Started

FR-2024 supports DCON protocol that is a request/reply communication protocol. Here we will demonstrate how to use DCON Utility to configure the FR-2024; it uses DCON protocol to test whether FRnet is working or not to help you get started with FR-2024.

### 2.1. Hardware Installation

FR-2024 are equipped with a RS-232 interface (TxD, RxD, GND), COM0, 4-pin connector. The demo will simply use a CA-0915 (9-pin female to 9-pin male) and a CA-0904 (4-pin female to 9-pin female) connector to connect FR-2024 to PC/Laptop as shown below:

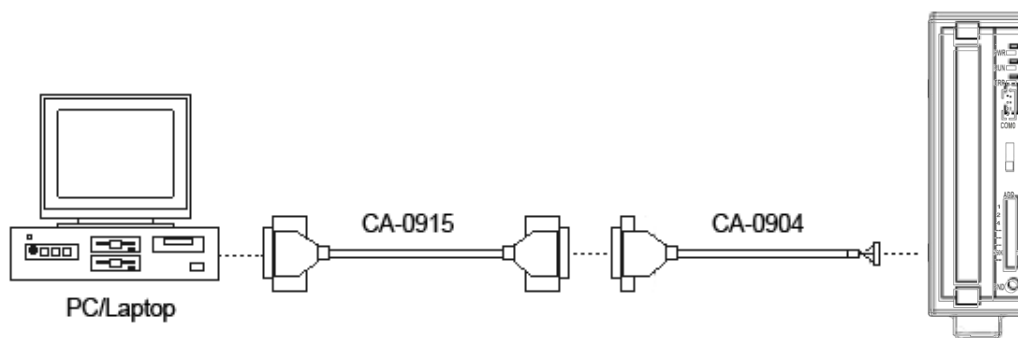

For more information about CA-0915 and CA-0904 connectors, please refer to:

[http://www.icpdas.com/products/Accessories/cable/cable\\_selection.htm](http://www.icpdas.com/products/Accessories/cable/cable_selection.htm)

If your PC/Laptop don't have a standard RS-232 port, you can use an I-7560 converter (USB to RS-232) and a CA-0904 converter (RS-232 to RS-485) to connect the FR-2024. Before using the I-7560, please make sure that the USB driver has installed.

The USB driver can be obtained from:

<ftp://ftp.icpdas.com/pub/cd/8000cd/napdos/7000/756x/>

## 2.2. Software Installation

The FR-2024 can be configured via a standard RS-232 serial port by using DCON Utility.

DCON Utility is a toolkit that helps users search the network, easily to configure the I/O modules and test the I/O status via a serial port (RS-232/485) or Ethernet port (using virtual com port).

The DCON Utility can be obtained at:

[ftp://ftp.icpdas.com/pub/cd/8000cd/napdos/driver/dcon\\_utility/](ftp://ftp.icpdas.com/pub/cd/8000cd/napdos/driver/dcon_utility/)

## 2.3. Configuration

The FR-2024 can be configured not only by a 6-bit DIP switch but also via DCON Utility.



The figure below shows the system configuration of the 6-bit DIP switch:

Dip Switch			Type Code	Min	Max
1	2	3			
ON	ON	ON	0 ~ 20mA	000 (0mA)	FFF (20mA)
OFF	ON	ON	4 ~ 20mA	000 (4mA)	FFF (20mA)
ON	OFF	ON	0V ~ +10V	000 (0V)	FFF (+10V)
OFF	OFF	ON	-10V ~ +10V	800 (-10V)	7FF (+10V)
ON	ON	OFF	0V ~ +5V	000 (0V)	FFF (+5V)
OFF	ON	OFF	-5V ~ +5V	800 (-5V)	7FF (+5V)
Dip Switch			Reserved		
4	5	6			
ON			Reserved		
OFF					
	ON		Safe value	Output safe values when FRnet communication failed	
	OFF			Output not changed when FRnet communication failed	
		ON	Software configuration	Software configuration	
		OFF		DIP switch configuration	



Here is a demo that shows how to use DCON Utility to configure FR-2024. Before starting this process, make sure that the software and hardware are successfully installed as described in the previous section.

Step 1: Start DCON Utility, and then configure protocol parameters

The screenshot shows the DCON Utility interface. A dialog box titled "Select the COM Port and Baud Rate..." is open. In the "COM to search:" section, "COM1" is selected from a dropdown menu. The "Time Out Setting" is set to 100 ms. Under "Baud Rate Option", the following rates are listed: 460800, 230400, 115200 (checked), 57600, 38400, 19200, 9600 (checked), 4800, 2400, and 1200. The "Protocol Option" section has "DCON" checked, "Modbus RTU" unchecked, and "Modbus ASCII" unchecked. The "Checksum Option" section has "Disable" checked and "Enable" unchecked. The "Parity Option" section has "None (N,8,1)" checked, "Even (E,8,1)" unchecked, "None (N,8,2)" unchecked, and "Odd (O,8,1)" unchecked. The "Industry Computer RS-485 Port Option" section has "RTS\_CONTROL\_TOGGLE" and "Set\_RTS (for Vision Box)" both unchecked. The "Cancel" and "Ok" buttons are at the bottom.

FR-2024 RS-232 protocol parameters:  
 Baud rate: 115200  
 Checksum : Disable  
 Parity : N, 8, 1

Step 2: Search the module, when finished, click the name of the I/O module to enter the configuration form in the list

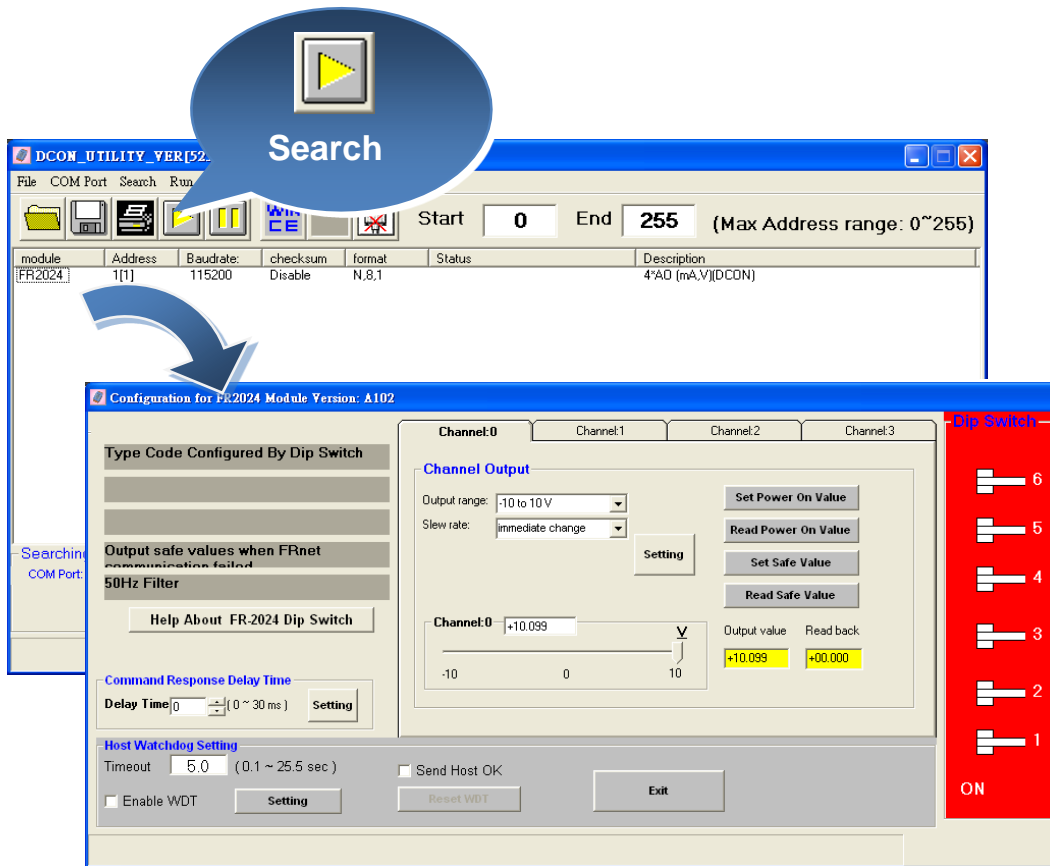

The following sections introduce some of the basic procedures of the FR-2024 configuration form of the DCON Utility.

- i. Getting help – FR-2024 configuration
- ii. Limiting the output
- iii. Configuring the operation settings

## 2.3.1. Getting help – FR-2024 Configuration

The 『Help About FR-2024 Dip Switch』 button allows users to get the configuration information of the FR-2024.

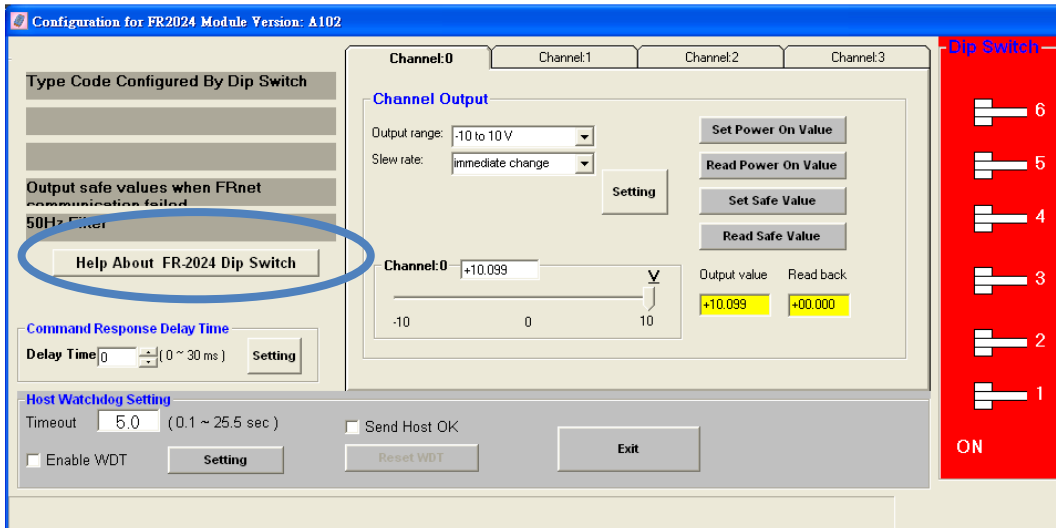

## 2.3.2. Limiting the Output

The 5<sup>th</sup> DIP switch allows the user to limit the output to a safe value or not.

### Output to a safe value

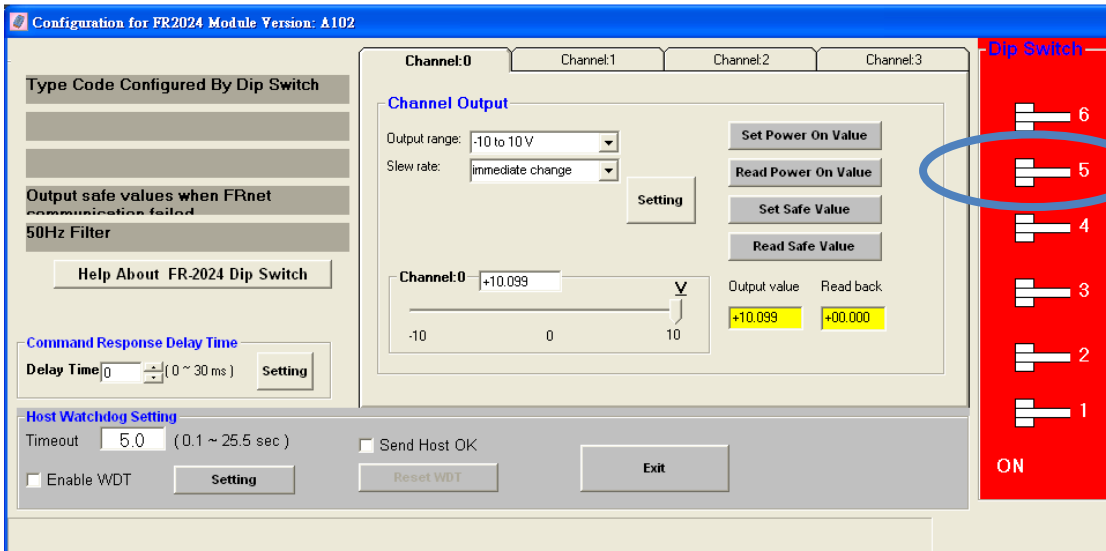

### Output not changed (Default)

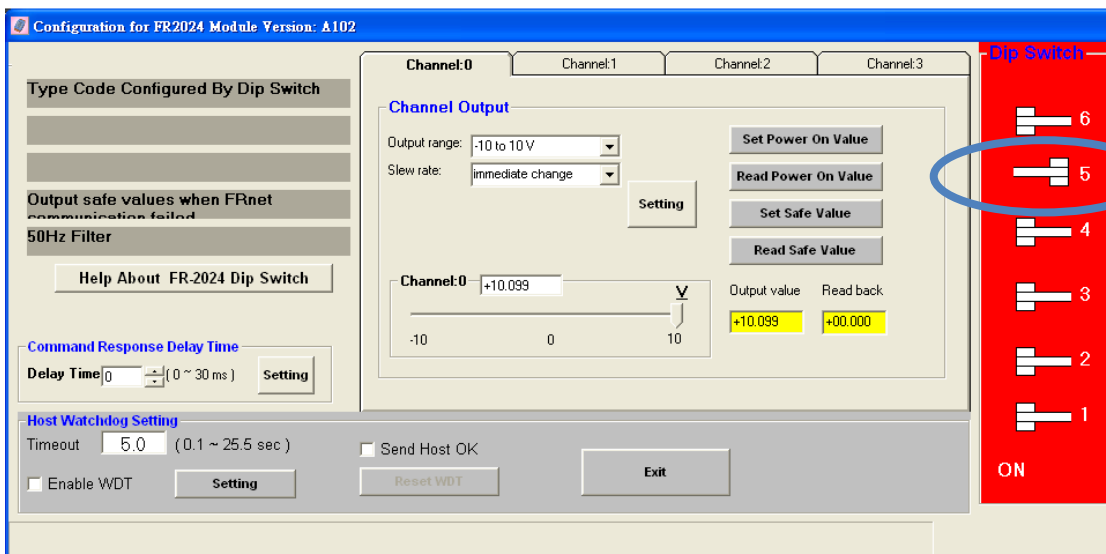

## 2.3.3. Configuring the Operation Settings

The 6<sup>th</sup> DIP switch allows the user to configure the output operation from hardware setting to software setting, and vice versa.

### The output operation from hardware setting

To choose the output operation from hardware setting, the output range can be configured from the 1<sup>st</sup> to 3<sup>rd</sup> DIP switches.

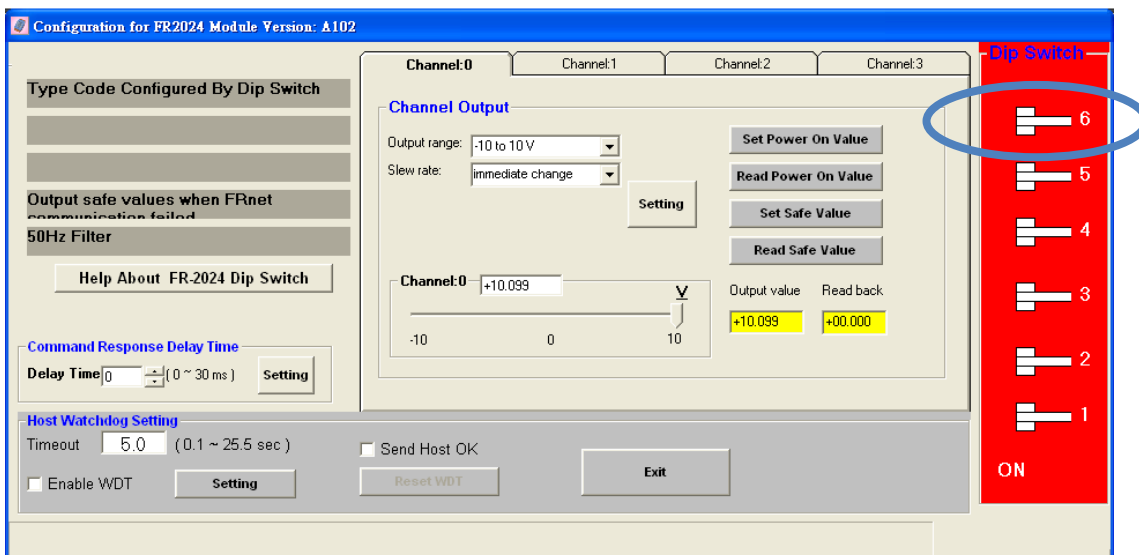

## The output operation from software setting (Default)

To choose the output operation from software setting, each channel can have different output range and slew rate.

Besides, users can monitor the configuration and the measured value by using DCON Utility configuration to contrast and debug the program.

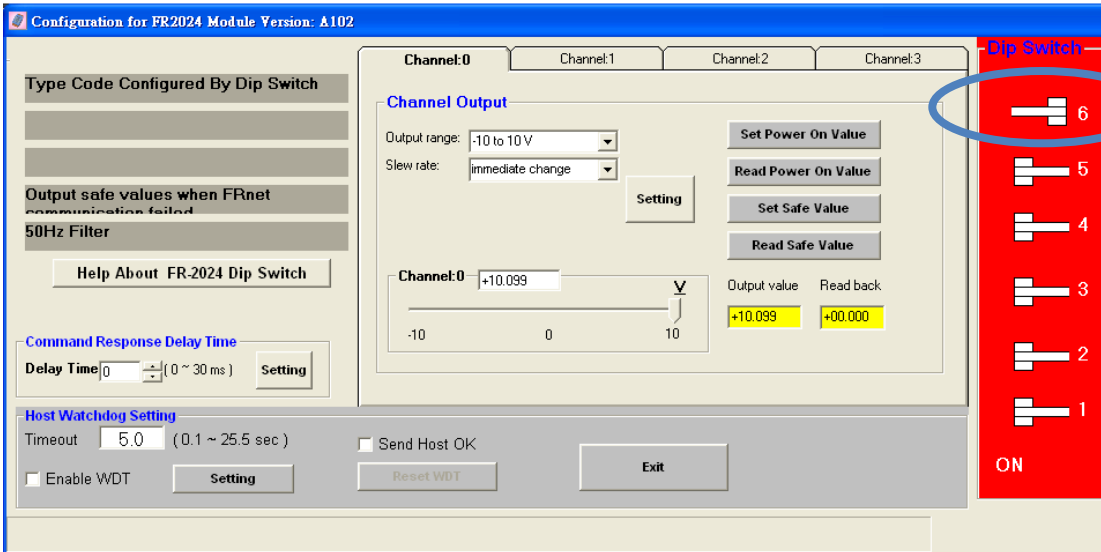

# 3. FRnet Application

Within conventional communication methods in the control network system, the master controller must send a command with data to the slave module. Then it must wait for confirmation from the slave's response, which is based on a complicated and fixed transmission protocol. If there are many devices on the network, all the data transmission within the network must be controlled by the master controller. Therefore, the performance of communication efficiency between the master controller and each of the devices will usually be deteriorated when more and more devices are added in. In contrast to this solution, our FRnet provides innovative data transmission method which adopts the hardware FRnet control chip to do communication broadcasting and gets rid of the software transmission protocol. It is easy to set up a reliable network merely by hardware setting both the "Sender Address" and "Receiver Address" of all the modules.

There are three FRnet master controllers provided by ICPDAS products, the PAC family, 7188EF-016, and the FRB-100/200. The first one is a PCI interface add-on card, and the other one is an Ethernet embedded controller. Three possible application configurations are demonstrated as follows. The following FRnet I/O modules are basic architectures that are available

# 1. PAC-Based System

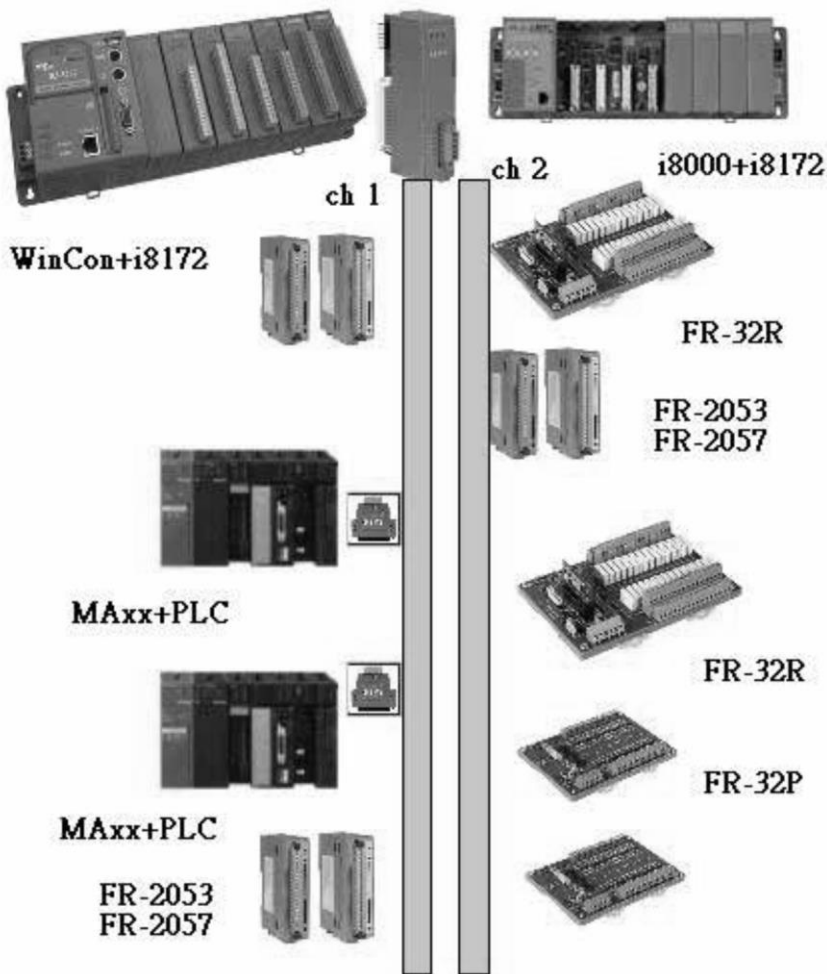

For more information about the I-8172 I/O module, please refer to:

[http://www.icpdas.com/products/Remote\\_IO/i-8ke/i-8172w.htm](http://www.icpdas.com/products/Remote_IO/i-8ke/i-8172w.htm)



## 2. uPAC-Based System

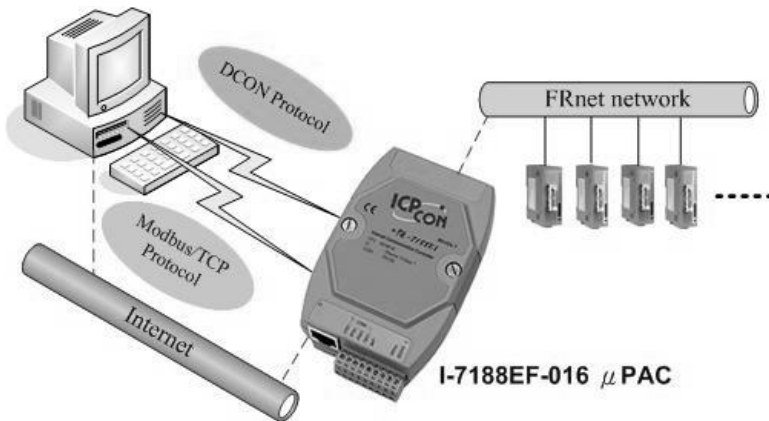

For more information about the FRB-100/FRB-200(U) module, please refer to:

[http://www.icpdas.com/products/Remote\\_IO/frnet/i-7188ef-016.htm](http://www.icpdas.com/products/Remote_IO/frnet/i-7188ef-016.htm)

## 3. PC-Based System

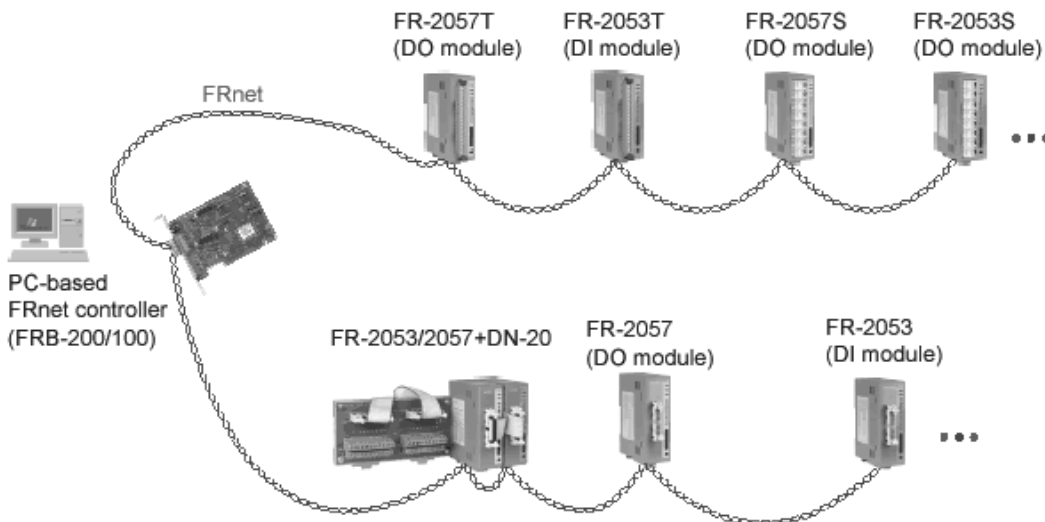

For more information about the FRB-100/FRB-200(U) module, please refer to:

[http://www.icpdas.com/products/Remote\\_IO/frnet/frb-200.htm](http://www.icpdas.com/products/Remote_IO/frnet/frb-200.htm)

Before using the FR-2024 development kits or other function to access data, please make sure the following settings:

## Group Number

The FR-2024 module can configure the group number by the dip-switch. The configuration method is depicted in the following figure:

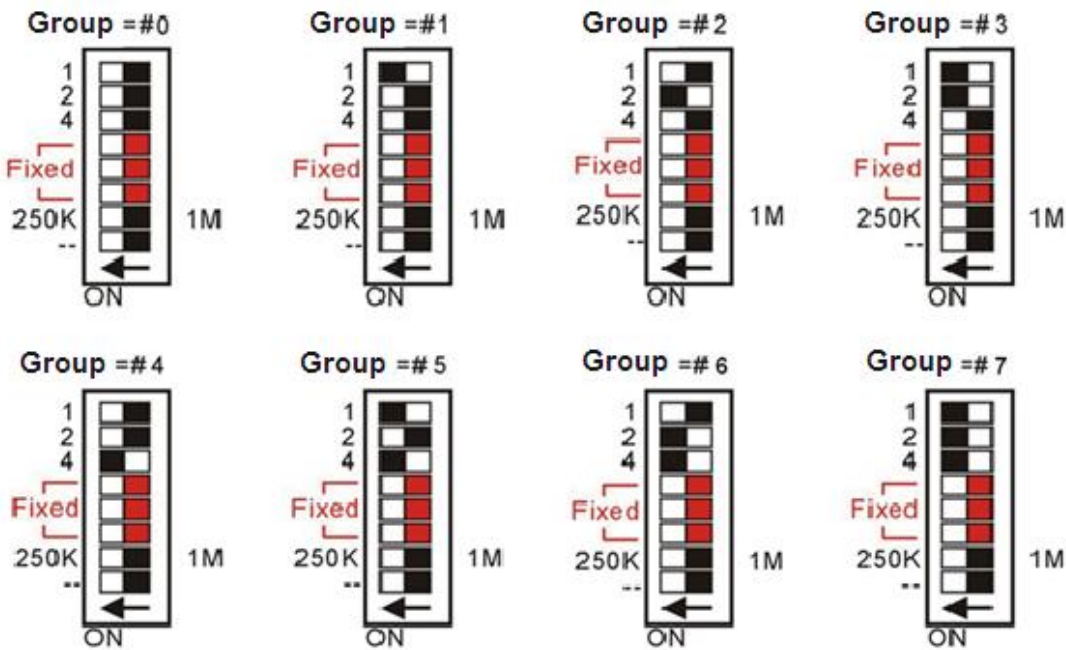

## 3.1. PAC-Based System

ICP DAS provides various series of PACs that can support the FRnet expanded I/O module via an I-8172 I/O module.

For more information about the I-8172 I/O module, please refer to:

[http://www.icpdas.com/products/Remote\\_IO/i-8ke/i-8172w.htm](http://www.icpdas.com/products/Remote_IO/i-8ke/i-8172w.htm)

The table below lists all the PAC library and demo program for supporting I-8172 I/O module:

Platform	Controller	API Comparison
MiniOS7	I-8000 Series iPAC-8000Series VP-2000Series	i8172_API name
Website	<a href="ftp://ftp.icpdas.com/pub/cd/8000cd/napdos/fr_net/8172/demo/bc/">ftp://ftp.icpdas.com/pub/cd/8000cd/napdos/fr_net/8172/demo/bc/</a>	
Windows CE5 /Windows CE6 / Windows Embedded Standard (WES)	WP-8000 series VP-2000 series XPAC-CE6 series XPAC-XPE series	pac_i8172W_API name
Windows CE5	<a href="ftp://ftp.icpdas.com/pub/cd/winpac/napdos/wp-8x4x_ce50/sdk/io_modules/">ftp://ftp.icpdas.com/pub/cd/winpac/napdos/wp-8x4x_ce50/sdk/io_modules/</a> <a href="ftp://ftp.icpdas.com/pub/cd/winpac/napdos/wp-8x4x_ce50/demo/winpac/">ftp://ftp.icpdas.com/pub/cd/winpac/napdos/wp-8x4x_ce50/demo/winpac/</a>	
Windows CE6	<a href="ftp://ftp.icpdas.com/pub/cd/xp-8000-ce6/sdk/special_io/">ftp://ftp.icpdas.com/pub/cd/xp-8000-ce6/sdk/special_io/</a> <a href="ftp://ftp.icpdas.com/pub/cd/xp-8000-ce6/demo/XPAC/">ftp://ftp.icpdas.com/pub/cd/xp-8000-ce6/demo/XPAC/</a> <a href="ftp://ftp.icpdas.com/pub/cd/xpac-atom-ce6/sdk/special_io/">ftp://ftp.icpdas.com/pub/cd/xpac-atom-ce6/sdk/special_io/</a> <a href="ftp://ftp.icpdas.com/pub/cd/xpac-atom-ce6/demo/XPAC/">ftp://ftp.icpdas.com/pub/cd/xpac-atom-ce6/demo/XPAC/</a>	
Windows Embedded Standard	<a href="ftp://ftp.icpdas.com/pub/cd/xp-8000/sdk/io/">ftp://ftp.icpdas.com/pub/cd/xp-8000/sdk/io/</a> <a href="ftp://ftp.icpdas.com/pub/cd/xpac-atom/sdk/io/">ftp://ftp.icpdas.com/pub/cd/xpac-atom/sdk/io/</a> <a href="ftp://ftp.icpdas.com/pub/cd/xp-8000/demo/specialized_io/">ftp://ftp.icpdas.com/pub/cd/xp-8000/demo/specialized_io/</a> <a href="ftp://ftp.icpdas.com/pub/cd/xpac-atom/demo/specialized_io/">ftp://ftp.icpdas.com/pub/cd/xpac-atom/demo/specialized_io/</a>	

### 3.1.1. i8172\_WriteAOHex

Write the analog output value in hexadecimal format for FR-2024.

#### Syntax

```
short pac_i8172W_WriteAOHex(int iSlot,int iPort,int iGroup,short bitMode,short iChannel,  
short aoHexData, short ifDelay);
```

#### Parameters

iSlot: 0 ~ 7.

iPort: 0 or 1.

iGroup: 0 ~ 7.

bitMode: 0 means 12-bit resolution, FR-2024 only support 12-bit resolution.

\*iChannel: The number of the specified channel are as 0 ~ 3.

\*aoHexData: Reads the analog output data of the specified channel.

delayTime: The delay time after FR-2024 write the analog output data.

#### Return Values

If the function fails, the return value is not 0.

## Remarks

For some application, program may use a for loop to write analog output by using `i8172_WriteAOHex`, but for FRnet protocol, each command will have 3 ms delay for 250K setting and 1 ms delay for 1M setting.

If there is no need to write analog output continuously, the `delayTime` may set as 0.

## 3.1.2. i8172\_WriteAOFloat

Write the analog output value in float format for FR-2024.

### Syntax

```
short pac_i8172W_WriteAOFloat(int iSlot,int iPort,int iGroup,short bitMode,short  
iChannel, short typeCode, float aoFloat, short ifDelay);
```

### Parameters

iSlot: 0 ~ 7.

iPort: 0 or 1.

iGroup: 0 ~ 7.

bitMode: 0 means 12-bit resolution, FR-2024 only support 12-bit resolution.

\*iChannel: The number of the specified channel are as 0 ~ 3.

typeCode: The output range of the specified channel are as 0 ~ 3.

0 x 30: 0 ~ 20 mA

0 x 31: 4 ~ 20 mA

0 x 32: 0 ~ +10 V

0 x 33: -10 ~ +10 V

0 x 34: 0 ~ +5 V

0 x 35: -5 ~ +5 V

\*aoHexData: Reads the analog output data of the specified channel.

delayTime: The delay time after FR-2024 write the analog output data.

## Return Values

If the function fails, the return value is not 0.

## Remarks

For some application, program may use a for loop to write analog output by using `i8172_WriteAOFloat`, but for FRnet protocol, each command will have 3 ms delay for 250K setting and 1 ms delay for 1M setting.

If there is no need to write analog output continuously, the `delayTime` may set as 0.

### 3.1.3. i8172\_AOHexToFloat

Convert the analog output data in hexadecimal to float format.

#### Syntax

```
float pac_i8172_AOHexToFloat(short hexData,short typeCode,short bitMode);
```

#### Parameters

fData: The analog output data in hexadecimal format of the specified channel are as 0 ~ 3.

typeCode: The output range of the specified channel are as 0 ~ 3.

0 x 30: 0 ~ 20 mA

0 x 31: 4 ~ 20 mA

0 x 32: 0 ~ +10 V

0 x 33: -10 ~ +10 V

0 x 34: 0 ~ +5 V

0 x 35: -5 ~ +5 V

bitMode: 0 means 12-bit resolution, FR-2024 only support 12-bit resolution.

#### Return Values

If the function succeeds, the return value is data in float format.



## 3.1.4. i8172\_AOFloatToHex

Convert the analog output data in float to hexadecimal format.

### Syntax

```
long pac_i8172_AOFloatToHex(float fData,short typeCode,short bitMode);
```

### Parameters

fData: The analog output data in float format of the specified channel are as 0 ~ 3.

typeCode: The output range of the specified channel are as 0 ~ 3.

0 x 30: 0 ~ 20 mA

0 x 31: 4 ~ 20 mA

0 x 32: 0 ~ +10 V

0 x 33: -10 ~ +10 V

0 x 34: 0 ~ +5 V

0 x 35: -5 ~ +5 V

bitMode: 0 means 12-bit resolution, FR-2024 only support 12-bit resolution.

### Return Values

If the function succeeds, the return value is data in hexadecimal format.

## 3.2. PC-Based System

The I-7188EF-016 is a  $\mu$ PAC with isolated FRnet, Ethernet, RS-485 and RS-232 ports.

I-7188EF-016 is designed to make that the host PC easily access the FRnet I/O module via Ethernet. I-7188EF-016 controls the distributed FR-2000 and FR I/O module via FRnet, and provides the Modbus and DCON protocol for host PC to access these FR I/O channels via Ethernet.

For more information about the I-7186EF-016/I-7188EF-016 module, please refer to:

[http://www.icpdas.com/products/Remote\\_IO/frnet/i-7188ef-016.htm](http://www.icpdas.com/products/Remote_IO/frnet/i-7188ef-016.htm)

I-7186EF-016/I-7188EF-016 accesses the FRnet I/O module via not only Ethernet but also the Modbus/TCP and the DCON command.

The following section introduces some of the function used to access the FR-2024 via Ethernet, and some of the Modbus and the DCON command via the Modbus/TCP and the DCON protocol.

- i. Access the FR-2024 via Ethernet (Please refer to 3.2.1 and 3.2.2)
- ii. Access the FR-2024 via the Modbus and the DCON command (Please refer to 3.2.)

## 3.2.1. FRnet\_WriteAOHex

Write the analog output value in hexadecimal format for FR-2024.

### Syntax

```
short FRnet_WriteAOHex(int group,short bitMode,short chIndex, short aoHexData, short needDelay);
```

### Parameters

group: 0 ~ 7.

bitMode: 0 means 12-bit resolution, FR-2024 only support 12-bit resolution.

chIndex: The number of the specified channel are as 0 ~ 3.

\*aoHexData: Reads the analog output data of the specified channel.

needDelay: The delay time, 3 ms, after FR-2024 write the analog output data.

### Return Values

If the function fails, the return value is not 0.

### Remarks

For some application, program may use a for loop to write analog output by using FRnet\_WriteAOHex, but for FRnet protocol, each command will have 3 ms delay for 250K setting and 1 ms delay for 1M setting.

If there is no need to write analog output continuously, the delayTime may set as 0

## 3.2.2. FRnet\_WriteAOFloat

Write the analog output value in Float format for FR-2024.

### Syntax

```
short Rnet_WriteAOFloat(int group,short bitMode,short chIndex, short typeCode, float  
aoFloat, short needDelay);
```

### Parameters

group: 0 ~ 7.

bitMode: 0 means 12-bit resolution, FR-2024 only support 12-bit resolution.

chIndex: The number of the specified channel are as 0 ~ 3.

typeCode: The output range of the specified channel are as 0 ~ 3.

0 x 30: 0 ~ 20 mA

0 x 31: 4 ~ 20 mA

0 x 32: 0 ~ +10 V

0 x 33: -10 ~ +10 V

0 x 34: 0 ~ +5 V

0 x 35: -5 ~ +5 V

\*aoFloat: Reads the analog output data of the specified channel.

needDelay: The delay time, 3 ms, after FR-2024 write the analog output data.

### Return Values

If the function fails, the return value is not 0.

## Remarks

For some application, program may use a for loop to write analog output by using FRnet\_WriteAOFloat, but for FRnet protocol, each command will have 3 ms delay for 250K setting and 1 ms delay for 1M setting.

If there is no need to write analog output continuously, the delayTime may set as 0

### 3.2.3. Modbus and DCON Commands

Here we will demonstrate how to use the I-7186EF-016/I-7188EF-016 to access the data through the DCON protocol or Modbus/TCP protocol.

The I-7186EF-016/I-7188EF-016 is available in firmware version 0x1010 or above. The latest version of the firmware can be obtained from:

[ftp://ftp.icpdas.com/pub/cd/8000cd/napdos/fr\\_net/7188ef/firmware/](ftp://ftp.icpdas.com/pub/cd/8000cd/napdos/fr_net/7188ef/firmware/)

#### DCON Protocol

Before using the DCON command to access the FR-2024, you need establish a connection between the host PC and I-7186EF-016/I-7188EF-016.

VxComm Utility can create a virtual COM port for using DCON protocol via Ethernet.

The VxComm Utility can be found at:

[ftp://ftp.icpdas.com/pub/cd/8000cd/napdos/driver/dcon\\_utility/](ftp://ftp.icpdas.com/pub/cd/8000cd/napdos/driver/dcon_utility/)

Step 1: Start VxComm Utility to create a virtual COM port

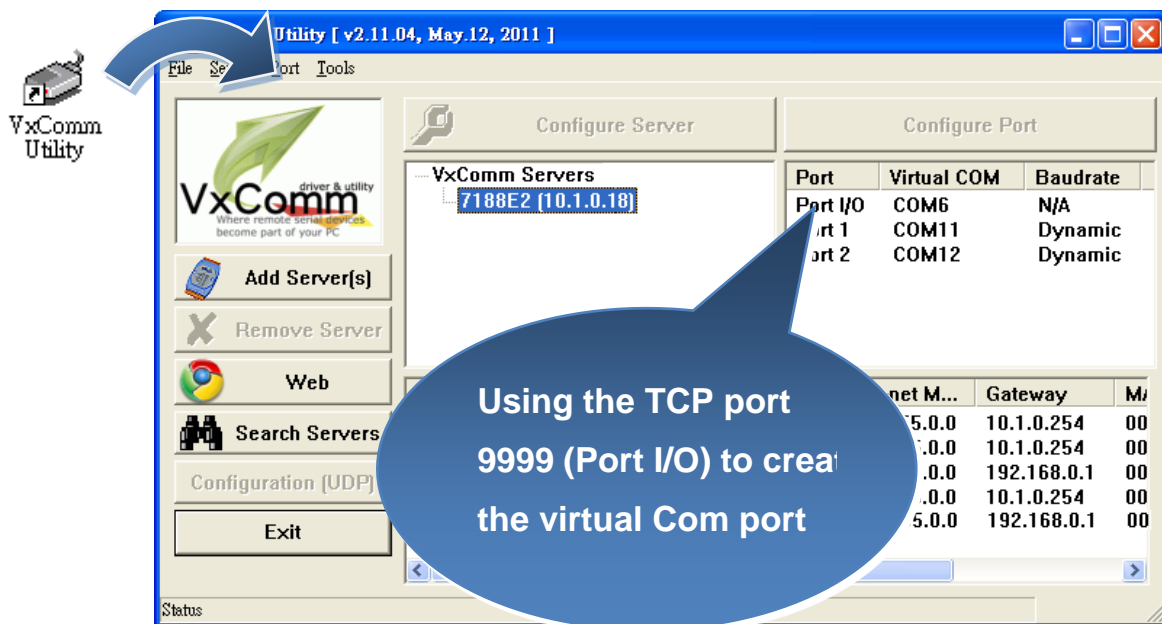

Step 2: Start DCON Utility to search the I-7186EF-016/I-7188EF-016 module through the establishment of the virtual COM port

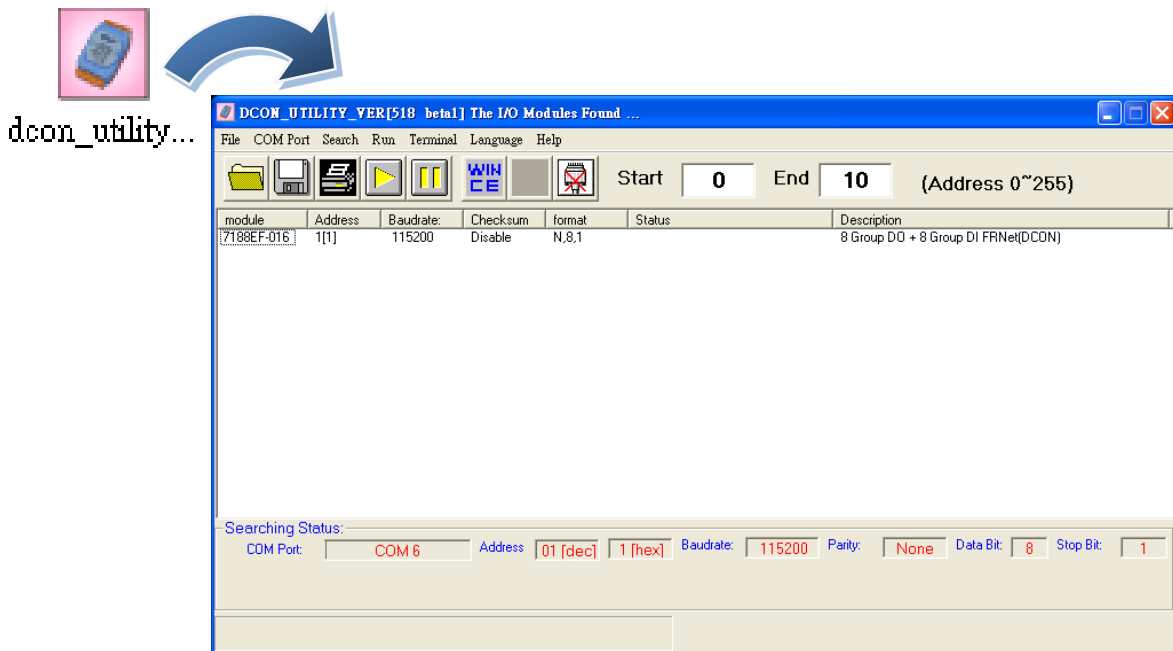

Step 3: Click the module name to enter the configuration form, and then click the Analog Output FRnet I/O tab.

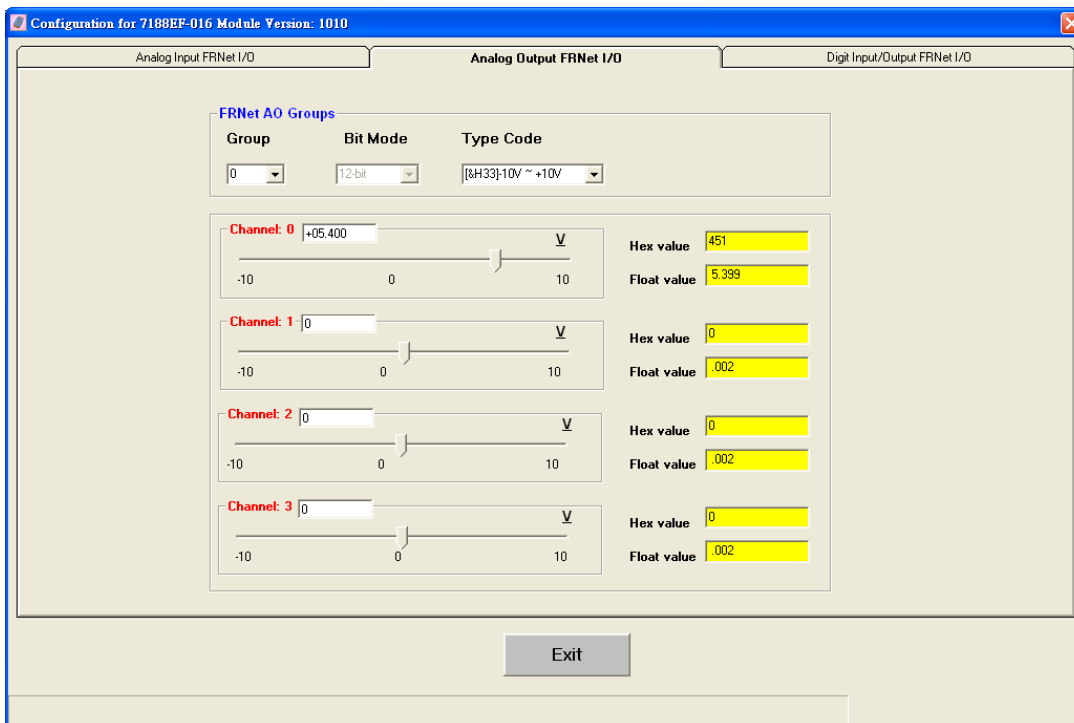

Step 4: Connect to FR-2024 to configure the settings. The step required to configure the following settings.

- i. Group: Group number
- ii. Output range

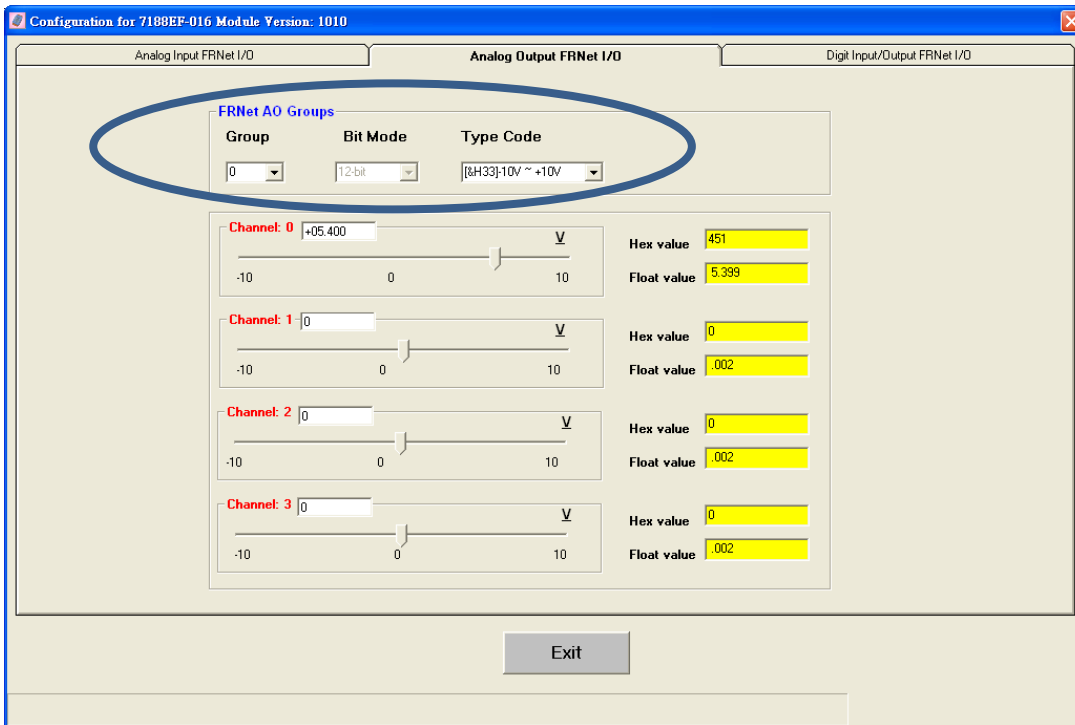



The following DCON commands are available for the I-7186EF-016/I-7188EF-016 to access the FR-2024.

<b>DCON Command</b>	<b>Description</b>	<b>Demo</b>
#AAGggBnCjTnn+00.000	Write float format channel data with bit mode and type code	
#AAGggBnCjTnn	Read float format channel data with bit mode and type code	

## Modbus/TCP Protocol

The Modbus command use Modbus function code 03 to read the analog input data of the FR-2024 via TCP port 502.

### FR-2024 Modbus Protocol Parameters

Address	Description
iMemory_AO range 40001 to range 40014 is reserved.	
40015	Group 0, 12-bit channel 0
40016	Group 0, 12-bit channel 1
40017	Group 0, 12-bit channel 2
40018	Group 0, 12-bit channel 3
iMemory_AO range 40019 to range 40046 is reserved.	
40047	Group 1, 12-bit channel 0
40048	Group 1, 12-bit channel 1
40049	Group 1, 12-bit channel 2
40050	Group 1, 12-bit channel 3
iMemory_AO range 40051 to range 40078 is reserved.	
40079	Group 2, 12-bit channel 0
40080	Group 2, 12-bit channel 1
40081	Group 2, 12-bit channel 2
40082	Group 2, 12-bit channel 3
iMemory_AO range 40083 to range 40110 is reserved.	
40111	Group 3, 12-bit channel 0
40112	Group 3, 12-bit channel 1
40113	Group 3, 12-bit channel 2

40114	Group 3, 12-bit channel 3
iMemory_AO range 40115 to range 40142 is reserved.	
40143	Group 4, 12-bit channel 0
40144	Group 4, 12-bit channel 1
40145	Group 4, 12-bit channel 2
40146	Group 4, 12-bit channel 3
iMemory_AO range 40147 to range 40174 is reserved.	
40175	Group 5, 12-bit channel 0
40176	Group 5, 12-bit channel 1
40177	Group 5, 12-bit channel 2
40178	Group 5, 12-bit channel 3
iMemory_AO range 40179 to range 40206 is reserved.	
40207	Group 6, 12-bit channel 0
40208	Group 6, 12-bit channel 1
40209	Group 6, 12-bit channel 2
40210	Group 6, 12-bit channel 3
iMemory_AO range 40211 to range 40238 is reserved.	
40239	Group 7, 12-bit channel 0
40240	Group 7, 12-bit channel 1
40241	Group 7, 12-bit channel 2
40242	Group 7, 12-bit channel 3
iMemory_AO range 40243 to range 40255 is reserved.	

## 3.3. uPAC-Based System

FRB-100/FRB-200(U) is a PC-based card that allows user to access the data of the distributed FR-net I/O modules.

For more information about the specification and related development applications of the FRB-100/FRB-200(U), please refer to the corresponding manual.

<http://www.icpdas.com/download/frnet/frb-200/frb-200.pdf>

## 4. Error Codes

The table below shows all of the error codes that are returned as integer values:

Value	Description
0	OK
-1	ID_ERROR
-2	SLOT_OUT_RANGE
-3	CHANNEL_OUT_RANGE
-4	MODE_ERROR